

Accessories

LIGHT COVERS

OMNI REFLECTIVE

The covers for our LED Balloon Lights inflate into an elegant and efficient balloon shape with air from the fans. We offer two different standard covers; the Omni Light Cover and the Reflective Light Cover. Designed to be used with our LED Lighting Systems, they are easy to attach and hold their shape perfectly. Contact us for even more customization options.



OMNI-DIRECTION/
REFLECTIVE



WATERPROOF



FLAMEPROOF



PHENOLIC
YELLOWING RESISTANT



WASHABLE

OMNI

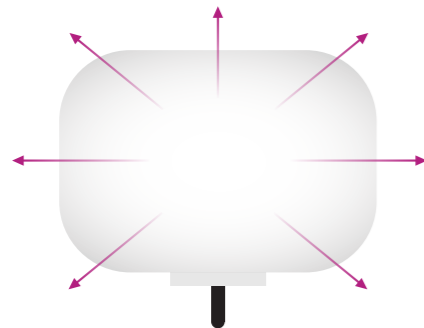

MINI 600 × 435 mm
MIDI 820 × 630 mm
MAXI 910 × 700 mm

Our Omni Light Covers produce omnidirectional, even lighting throughout a space. The covers are washable, easily replaced, waterproof, tear and flameproof. They are ideal for situations that require true omnidirectional illumination like photography and tunneling.

REFLECTIVE

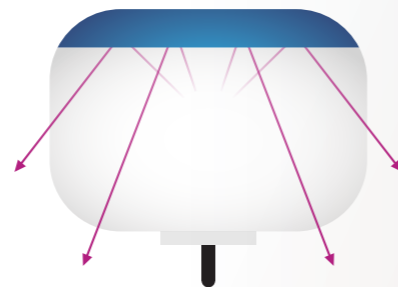

MINI 600 × 435 mm
MIDI 820 × 630 mm
MAXI 910 × 700 mm

Our Reflective Light Covers reflect light down onto the ground, acting as highly efficient street lights. The covers are washable, easily replaced, waterproof and flameproof. They minimize light pollution and are ideal for roadworks and construction.



for
**LED
Balloon
Light**
System



Accessories

TRIPODS

X SMALL SMALL MEDIUM LARGE

Our tripods are designed to integrate seamlessly into our lighting systems. Compact and reliable, they are a breeze to carry and collapse easily for storage. They can extend from a height of 1 meter to 4 meters. Safety features include a safety-chain to prevent accidental disconnection as well as a T-knob that can be tightened for extra safety. Tripods include a system for power cord storage and leg fasteners for safe transportation.

The color and structure of our tripods can be customized.
Dimension tolerance: ±10 mm



Height (min-max) 825-1600 mm
Width 880 mm
Weight 2.6 kg
Collapsed Height 770 mm
Collapsed Width 120 mm

Height (min-max) 1050-2035 mm
Width 880 mm
Weight 3.2 kg
Collapsed Height 930 mm
Collapsed Width 120 mm

Height (min-max) 1450-2180 mm
Width 1110 mm
Weight 7.4 kg
Collapsed Height 1340 mm
Collapsed Width 180 mm



Cable Hook + Storage



Integrated Ruler



Safety Chain



Anchor Holes



Articulated Feet



Cable Hook



Cable Hook
Cable Storage



Maximum Height
Red Mark



Safety Chain



Anchor Holes



Security T-Knob



Cable Velcro

for

LED
Balloon
Light
System

Mobile
Lighting
Tower
System



LARGE

for
MAXI LED
Balloon
Light

Height (min-max) 1740-3700 mm
Width 1500 mm
Weight 17 kg
Collapsed Height 1980 mm
Collapsed Width 210 mm



Accessories

TROLLEYS

SMALL MEDIUM LARGE

for

LED Balloon Light System Mobile Lighting Tower System



Our trolleys are the perfect size to transport generators. Made from strong steel with four sturdy wheels, they are as mobile as they are robust. Packed full of safety features, our trolleys make moving equipment a breeze.

The color and structure of our trolleys can be customized.
Dimension tolerance: ±10 mm



- 1 Stackable
- 2 Adjustable Stabilizer Legs
- 3 Fail-Safe Lock
- 4 I/O Switch
- 5 Generator Safety Belt
- 6 Crane-Hook Hole
- 7 Rubber Swivel & Brake Wheels

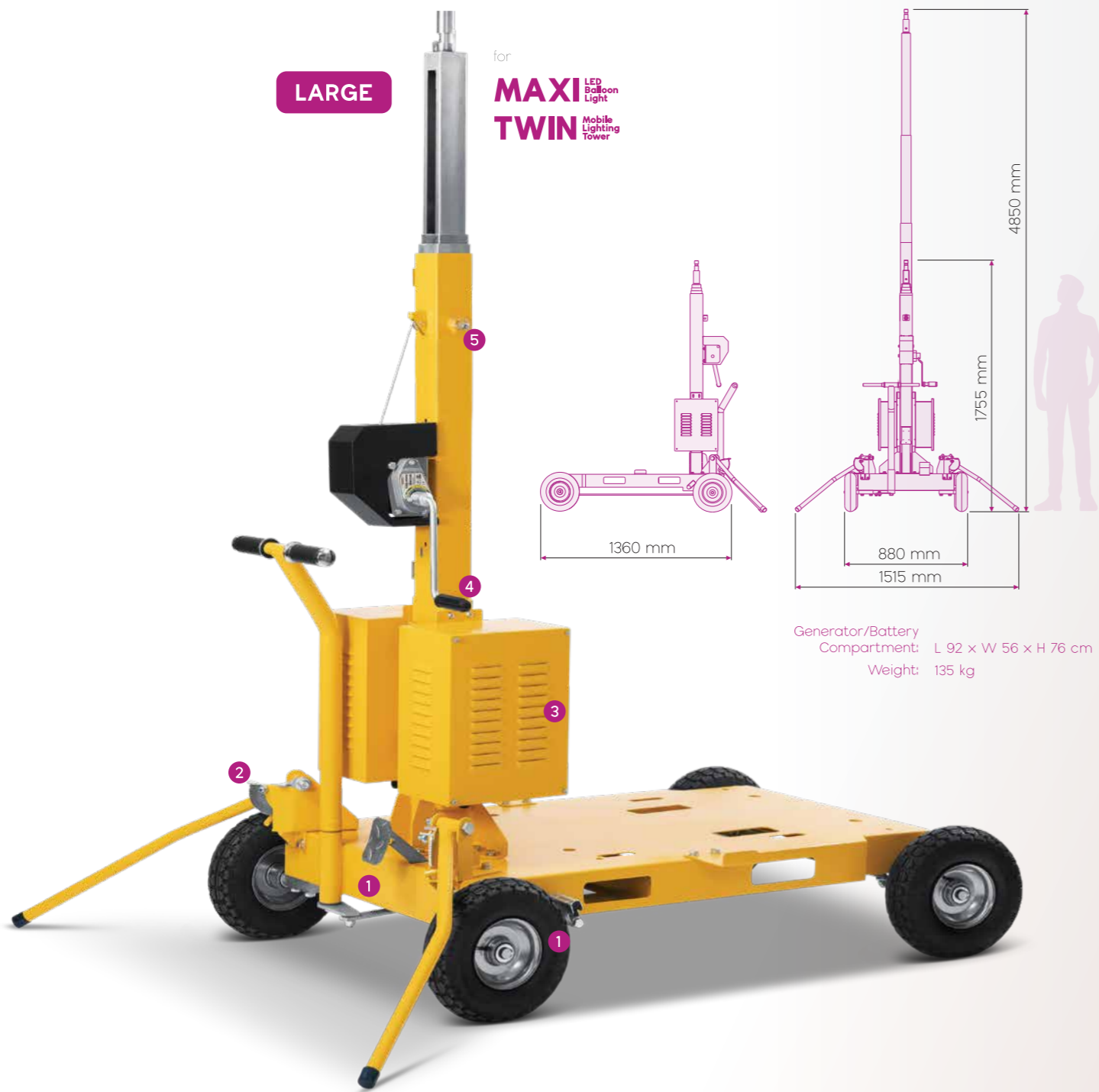

LARGE

for
MAXI TWIN LED Balloon Light Mobile Lighting Tower

Generator/Battery Compartment: L 92 x W 56 x H 76 cm
Weight: 135 kg



LARGE



SMALL



MEDIUM



Brake Pedal



Adjustable Stabilizer Legs



Compartment



Telescopic Pole Crank





Telescopic Pole Safety Pin

LED Light Customization Possibilities

Our lights can be customized to allow their color to be adjusted across the **RGB** spectrum or converted to **fog lights**. In addition, a **timer** can set how many seconds different colors display. Lights can also be **customized to a specific color** for purposes like emergency or security lights. **Dimmers** controlled by manual or **remote control** switches can also be installed or use our latest **APP** for full control of your lights via smartphone.

The shape of our light covers can be customized, as can the color and structure of our trolleys and tripods.

 Light color adjustable across the RGB spectrum.

 Dim light manually or by remote control.

 Switch between fog and white light.

 Use remote to control timer, dimmer and turn lights on and off.

 Set timer to change colors at intervals.

 APP controlled functionality like dimming and RGB mood lighting.

 Set correlated color temperature between 2500 K and 6500 K.

 Solar panel connectivity.

